

Operating Instructions

Suitable for the models of E400 series and E401 series

Safety precautions

Explanation of symbols



Refers to potentially dangerous situation that may cause serious injury or death .



Refers to potentially dangerous situation that may cause injury or property losses .



Refers to forbidden to do .



MUST BE ABIDED

Refers to abide by the rules .



The supplier shall not be liable for any loss arising from the failure to comply with the following regulations

- 1.This equipment is “I” type electric appliance, must be completed connected to the grounding system
- 2.This equipment is electric appliance, please do not be installed at the place where can easily be splashed with water or high temperature. Please install exhaust fan or ventilation opening to make sure there is a good ventilation when using at Bathroom.
- 3.If the supply cord is damaged, it must be replaced by the manufacturer, its service agent or similarly qualified persons in order to avoid a hazard.

Safety precautions



FORBID

1. Do not insert or remove power plug with wet hands .
Otherwise there is a risk of electric shock .
2. Do not damage the power cord and plug.
Otherwise there is a risk of electric shock, short- circuit and fire.
3. Do not use the loose socket.
Otherwise there is a risk of electric shock and fire.
4. The power supply must be accorded with regulation.
Otherwise there is a risk of damage the product and fire.
5. Do not disassemble , repair or reassemble the product.
Otherwise there is a risk of electric shock and fire.
6. Do not place a stove or a cigarette near the product.
Otherwise there is a risk of fire.
7. Make sure not to splash water ,detergents or urine on the product
and the power plug.
Otherwise there is a risk of electric shock,damage the product and
fire
8. Do not turn the product upside-down.
Otherwise this might cause product damage.
9. Do not bend or distort the inlet hose.
Otherwise there is a risk of water leakage.

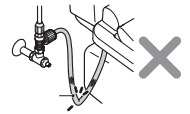
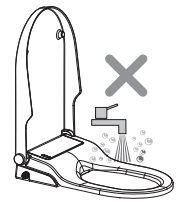

Technical Specification

MODEL		E400-F011
Wash	Rear Wash	●
	Female Wash	●
	Oscillating Spray	●
	Pulsating Spray	●
	Oscillating and Pulsing Spray	●
	Adjustable Water Temperature	5 Steps (Default 3rd)
	Adjustable Flow Rate	5 Steps (Default 3rd)
	Adjustable Spray Position	5 Steps (Default 5th)
Warm Air	Air Drying	●
	Adjustable Dryer Temperature	5 Steps (Default 3rd)
Hygiene	Deodoriser	●
	Nozzle Self Cleaning	●
	Nozzle Manually Cleaning	●
	User Mode	2 Users
	Night Light	●
	Ambient Light	●
	Soft Closing Seat And Cover	●
	Quick Release Seat And Cover	●
	Body Knob	●
	Remote Control	●
	Rimless Toilet	●
	Installation of the toilet	Pedestal
	Water Supply Connector	G 3/8
	Rated Voltage	AC220-240V, 50/60HZ
	Power	950W
	Length Of Power Cord	1.8m
	Water Supply Pressure	0.07~0.75MPa (0.7~7.5Bar)
	Water Supply Temperature	4~35°C
	Ambient Temperature	4~40°C
	Waterproof Rating	IPX4
Wash Device	Flow Rate	350~650mL/min
	Water Temperature	31~39°C
	Wash Cycle Time	3 Minutes
	Heating Mode	Tank
	Maximum Heater Power	1260W
	Safety Device	Thermal Cutoff Fuses\Liquid Level Switch\Thermostat
	Backflow Prevention	Air Gap
Dry Device	Maximum Speed Of Air	5m/S
	Maximum Dryer Power	280W
	Dry Cycle Time	3 Minutes
	Warm Air Temperature	35~50°C
	Safety Device	Thermal Cutoff Fuses\Thermostat
Deodorization	Deodorization Mode	Diatom
	Deodorization Cycle Time	15 Minutes
Remote Control	Frequency Range	2460MHz
	Maximum RF Output Power	-10dBm
	Type of batteries	1.5V LRO3 AAA
	Number of batteries	Two pieces
	Other Safety Device	Residual Current Devices
	Net Weight	35Kg
	Dimension	593*370*460 mm

Technical upgrade will be edited into the new version instruction without additional notice. Please follow the real if it is different from the nominal in shape ,color and accessories.

Technical Drawing

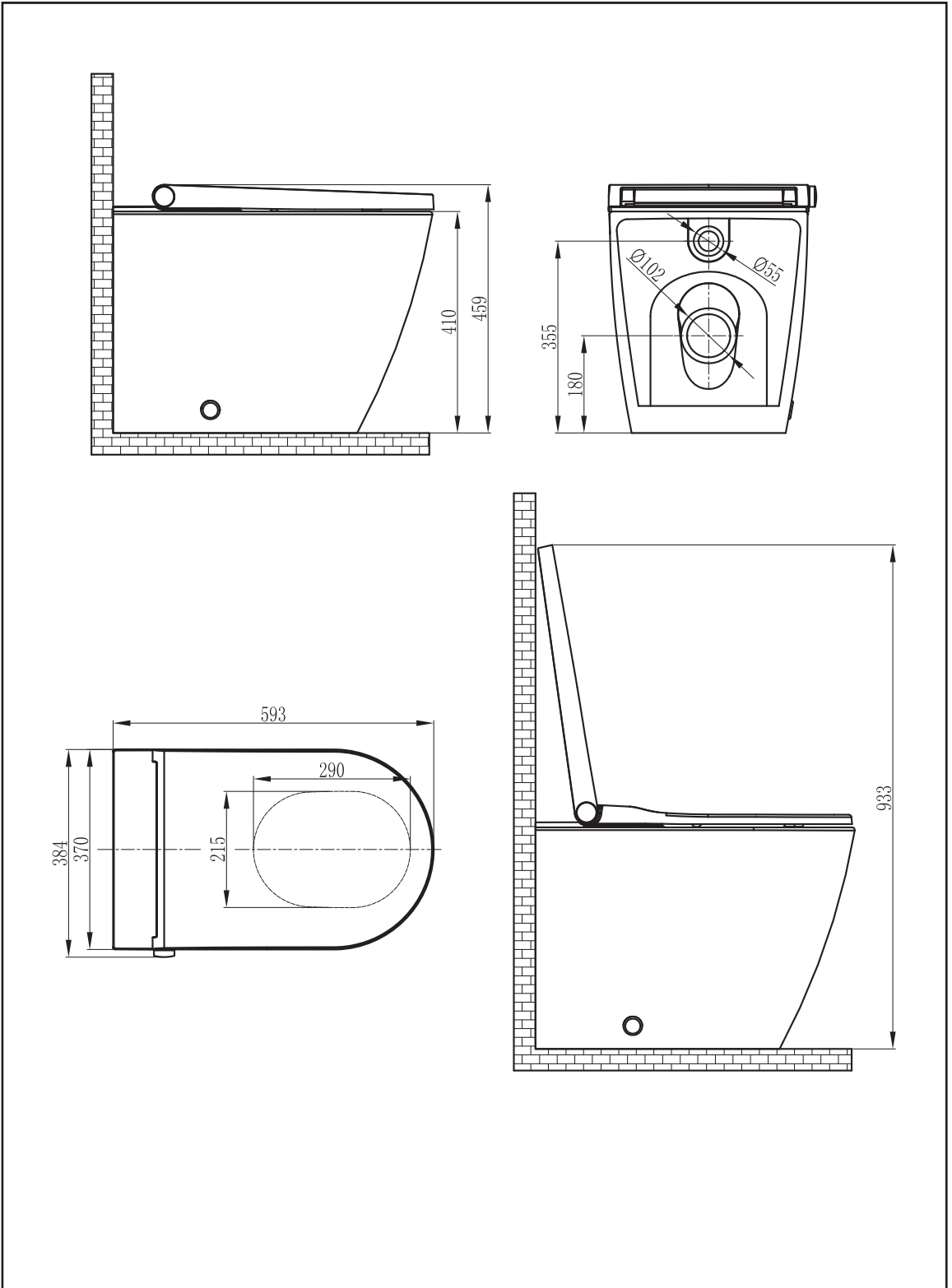

Overview

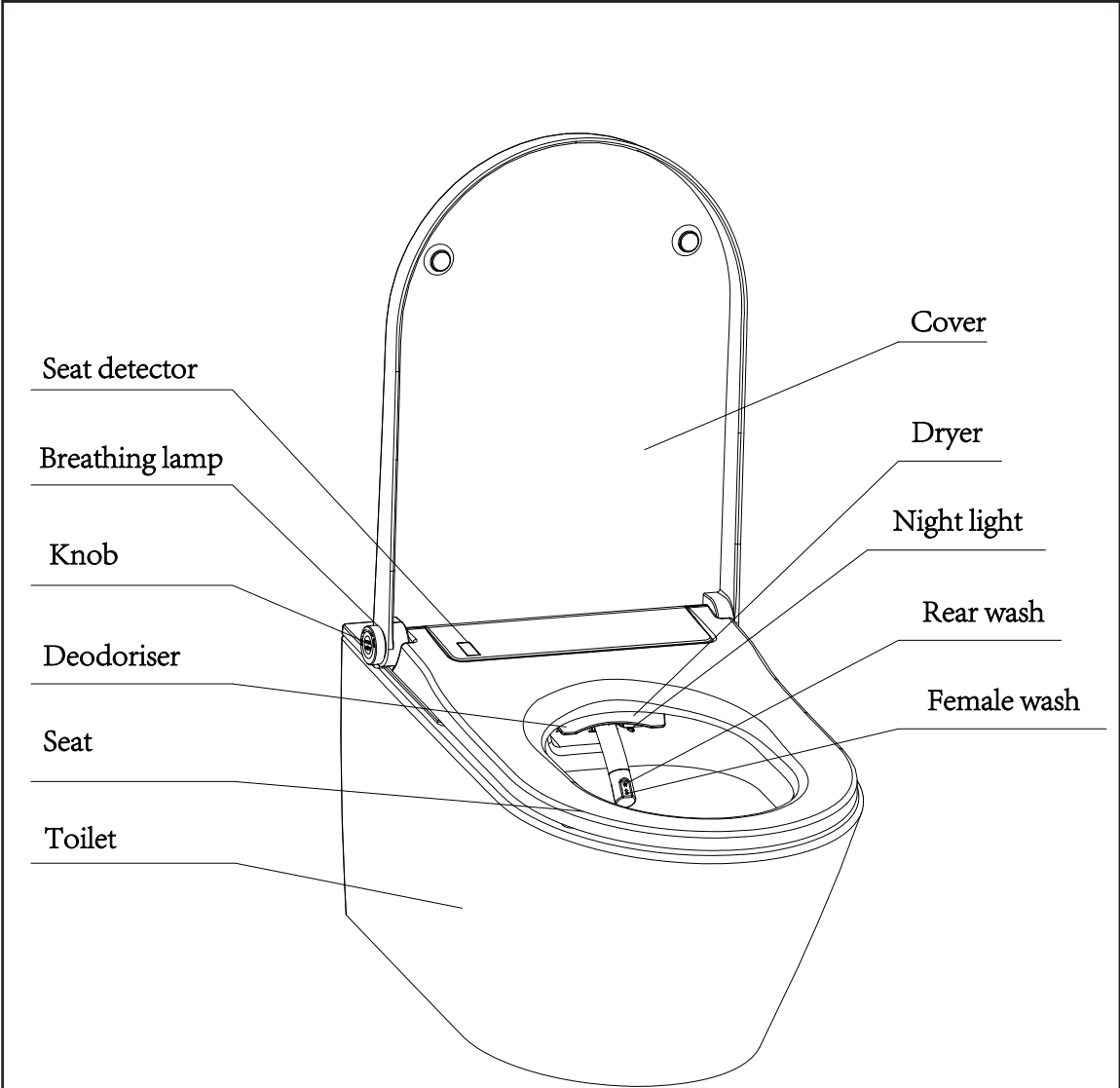

The pictures of this intruction is for reference only .
Please subject to the actual product .

Remote Control

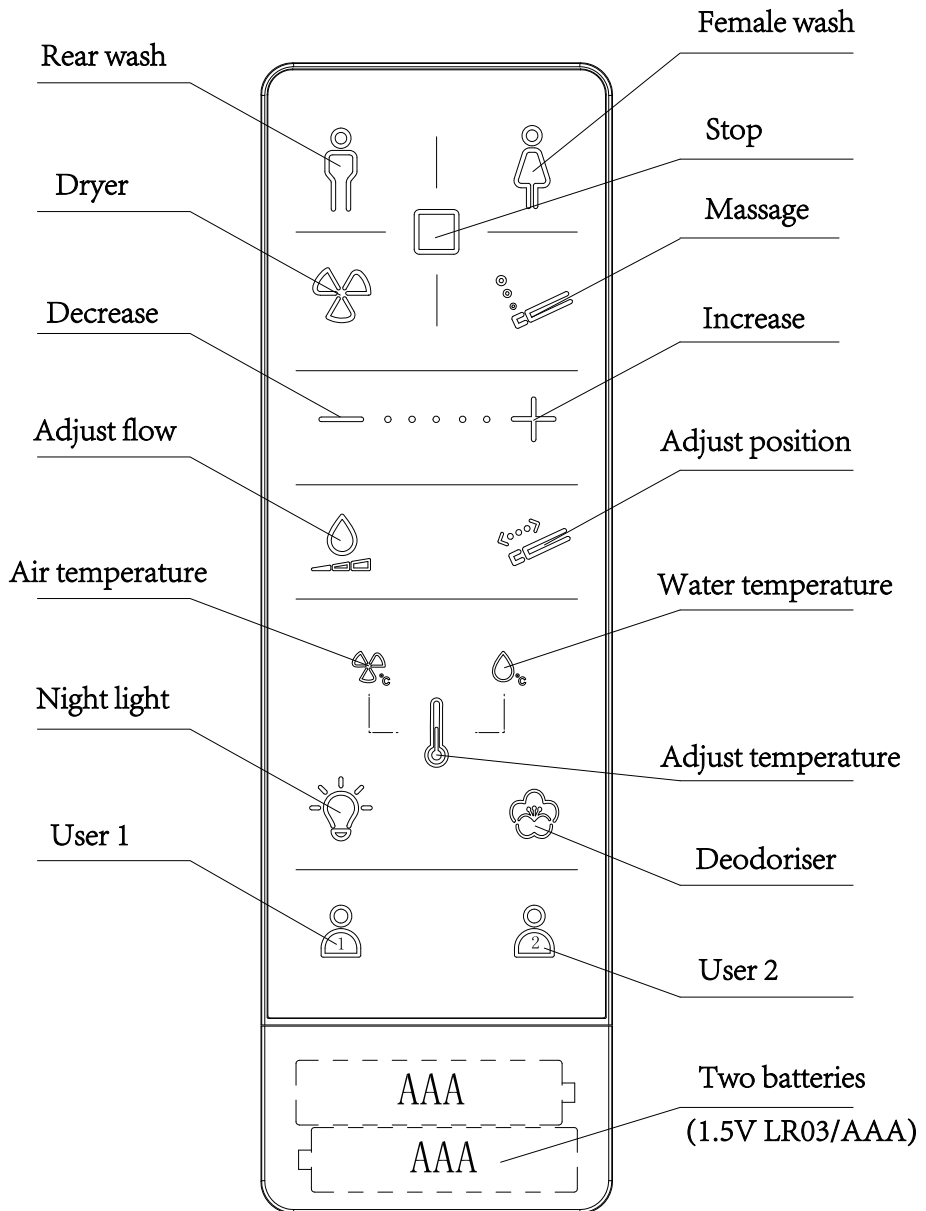

1. Before using, the remoter requires 2 batteries (type 1.5V LR3/AAA)
2. The followed remote-control operation is only for the model with the remote control
3. Versions of Software : V1.0
(The software updates will not be notified. Please follow the real remote control.)

Rear wash /Female wash

● Be seated

Press the "Wash" button on the remote control then it start to wash.
It will stop after 3 minutes . You can stop washing before this by pressing the "Stop" button.

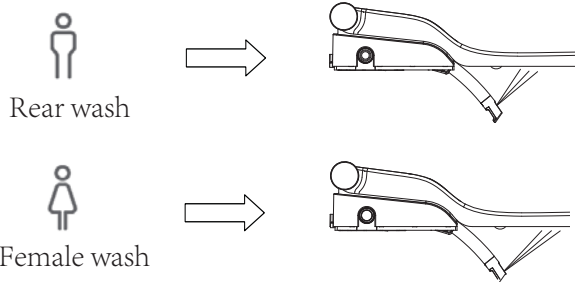

OR

You can operate by rotating the knob . Rotate the knob in the clockwise direction to activate "Female wash" and the anticlockwise direction for "Rear wash". It will stop after 3 minutes and start to dry . You can stop washing before this by pressing the "Stop" button.

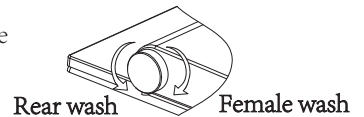

Note: While Rear wash or Female wash , it will wash at the fixed position for about 10 seconds , and movable wash for about 18 seconds , then regain to the fixed position until to the end .

Dry Operation

● Be seated

Press the "Dry" button on the remote control then it start to dry.
It will stop after 3 minutes



OR

- Be seated
- It is not in the process of Rear or Female washing

Press the knob then it start to dry . It will stop drying after 3 minutes

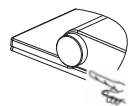

NOTICE All the operation is just for the model with all features . If the model what you bought has no the feature , please ignore the corresponding operation .

Massage Operation

- In the process of Rear or Female washing

Repeatedly press the "Massage" button on the remote until to choose your desired spray mode

Oscillating : when one indicator light is on

Pulsating : when two indicator lights are on

Oscillating + Pulsating : when three indicator lights are on



Stop Operation

- In the process of Rear washing , Female washing or drying

Press the "Stop" button on the remote control it will stop washing or drying .

OR

Press the knob it will stop washing or drying

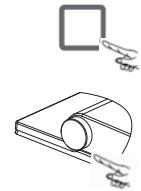

Adjusting water flow rate

- In the process of Rear or Female washing

Press the " Adjust flow " button on the remote control , then press the "Decrease" or " Increase " button to adjust the flow rate .

OR

You can operate by rotating the knob . The flow rate will increase in the clockwise direction and decrease in the anticlockwise direction .

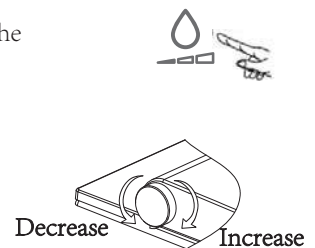

Adjusting the nozzle position

- Default 5 th
- In the process of Rear or Female washing

Press the " adjust position " button on the remote control, then press the "Decrease" or " Increase " button to adjust the nozzle position forward or backward.

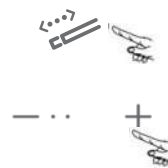

Adjust temperature

1. Adjust water temperature

- In the process of Rear or Female washing

Repeatedly press the " Adjust temperature " button on the remote control until the water temperature icon is lihgted , then press the " Increase " or " Decrease " button to adjust water temperature .

OR

Keep press the knob and rotate it. The water temperature will be increased in the clockwise direction and be decreased in the anticlockwise direction .

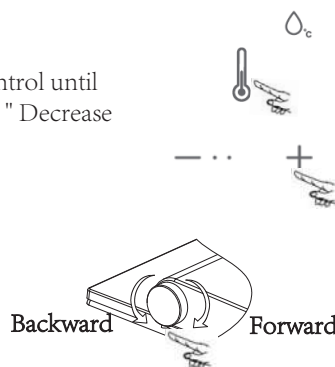

2. Adjust air temperature

- In the process of drying

Repeatedly press the " Adjust temperature " button on the remote control until the air temperature icon is lihgted , then press the " Increase " or " Decrease " button to adjust air temperature .

OR

You can operate by rotating the knob . The air temperature will be increased in the clockwise direction and be decreased in the anticlockwise direction .

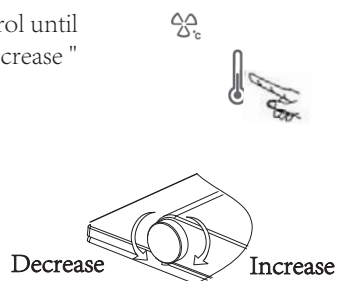

Light Setting

- Always on mode for the night light by default

Repeatedly press the " Night light " button on the remote control to choose the different mode .



Close mode : when one indicator light is on

— . +

Always on mode : when two indicator lights are on

— . . +

Smart mode : when three indicator lights are on

— . . . +

OR

Open the cover and seat , not be seated , then rotate the knob in the anticlockwise direction. The night light will be on the diferent mode just as "close", "always on", "smart".

NOTE: The "smart" mode refers that the night light will light up in a dark environment and light off in a bright environment.

Deodorize Setting

- Smart mode for the deodorization by default . It is on when the user sits down and it will be off after one minute when the user leaves .
If there is no operation of washing or drying during being seated , it will be off after 15 minutes.

Repeatedly Press the " Deodorization " button on the remote control to open or close the deodorization .



Close mode : when one indicator light is on

— . +

Smart mode : when two indicator lights are on

— . . +

OR

Open the cover and be seated , without washing and drying , then always press the knob and rotate it in the clockwise or anticlockwise direction. The deodorization will be on or off .

Breathing lamp setting

- Always on by default

Open the cover and be seated, without washing and drying, then always press the knob for 6S. The breathing lamp will be lighted off. It will be lighted up again when pressing the knob for 6S.

User Setting

1. Save the user setting

After adjusting the settings of water flow rate, temperature and nozzle position, keep pressing the "User 1" or "User 2" button on the remote control for more than 3 seconds to save the settings to "User 1" or "User 2"



2. Retrieve the user settings

Before washing or drying press the "User 1" or "User 2" button on the remote control, then operate washing or drying. The flow rate, water temperature, nozzle position, and air temperature will be the same as saved.



Power Standby Setting

- In the state without seating

Keep pressing the knob for more than 6 seconds, it will go into power standby mode. Press again the knob for more than 6 seconds to restart it.

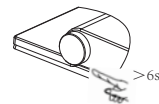

Sound setting

- The sound is on by default. There is a BEEP when the bidet has received commands or signals

Open the cover and seat.

Keep pressing the knob then rotate it. The sound is on in the clockwise direction and off in the anticlockwise direction.

Care and cleaning

● General care and cleaning recommendations

Cleaning interval	Cleaning activity
Daily	Remove water drops with a soft , lint-free cloths to avoid limescale stains
Weekly	Clean all surfaces and corners .Clean the spray nozzle if required. See "Nozzle cleaning "
Monthly	Clean the WC ceramic appliance with a low acidic cleaning agents
Every half year	Replace the filter if required. See "Replacing the filter"

● Cleaning agents and tools

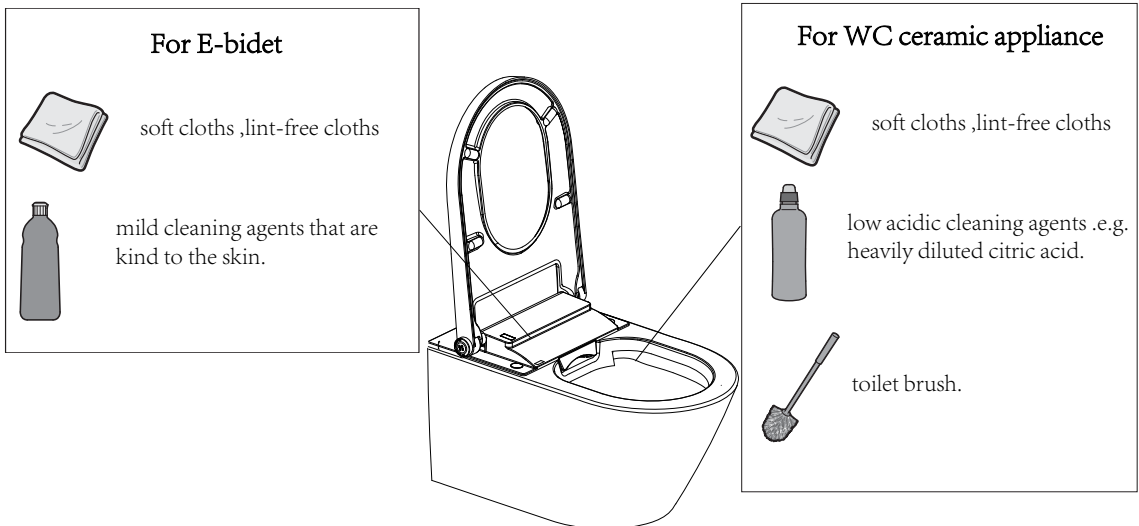

Do not use the cleaning agents of strong acid and alkali
 To clean the E-bidet , do not use the hard brush .e.g. toilet brush nylon brush
 To clean the WC ceramic appliance ,do not use the matal brush

Self-clean the tank



Not used for more than 72 hours, when the user operates the washing ,it will open the self-cleaning for about 3 minutes. All the buttons are invalid during the self-cleaning and it will return to normal after the self-cleaning.

Nozzle cleaning

- The nozzle will be cleaned before washing and after washing .

The operation of manual cleaning is as follows
 Open the cover and seat then rotate the knob in the clockwise direction .Then the nozzle will extend with cleaning water. It will return after 5 minutes or press the " stop " button .

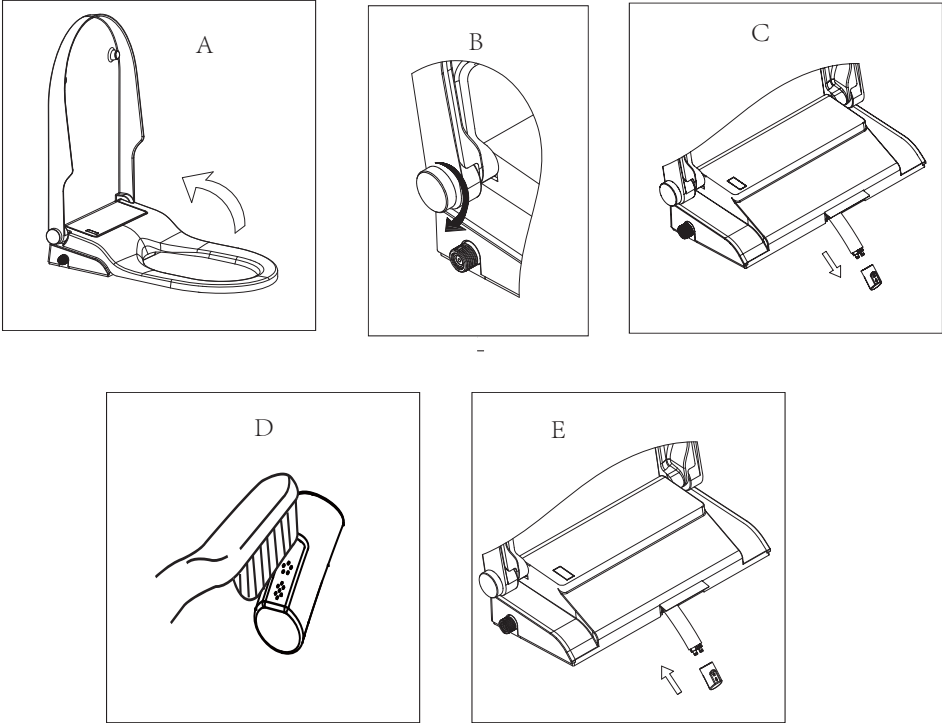

Replacing the filter

- The filter has a service life of half a year . This is depended on the environment of water.
 The filter should be replaced when the wash flow is too small .

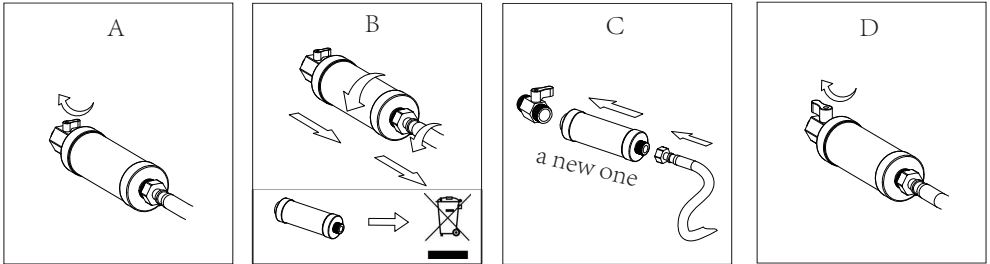

Drain the water tank



1. The water and power must be cut before you disassemble the E-Bidet
2. Do not invert or tilt it before you finish draining the water tank

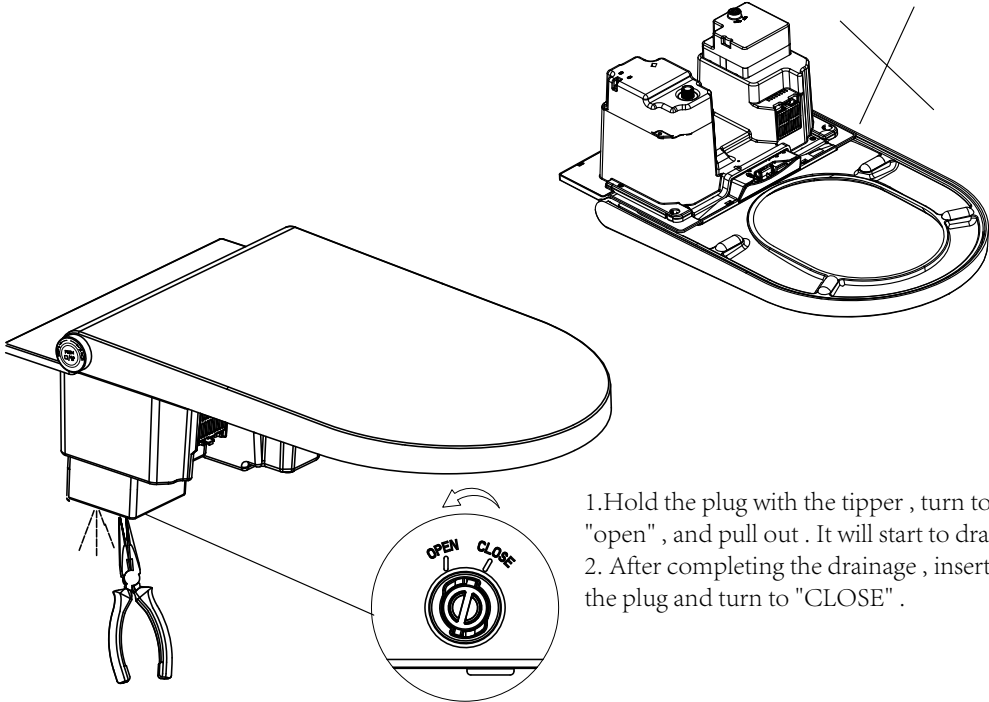

1. Hold the plug with the tipper , turn to "open" , and pull out . It will start to drain .
2. After completing the drainage , insert the plug and turn to "CLOSE" .

One-ON-One Setting

- Install several electronic bidets in the same area, if you want each remote control to control the specified electronic bidet, please complete setting as per following steps.

1. Open both cover and seat and without seating, Set the night light to the "close" model (just see the "Light setting").
2. Press the "stop" button and "adjust temperature" button on the remote control at the same time, and keep pressing for a few seconds, then hear the beep from the product and meanwhile the indicator lights of "-", "+" buttons are on.
3. Release the "stop" button, but keep pressing the "adjust temperature" button
4. Press the "USER1" and "USER2" in order, and then release the "adjust temperature" button. At this time, the lighted indicator is the current ID code of product
5. By pressing "-", "+" buttons to switch different product ID code with corresponding indicator lights up. There are 10 ID codes in total. It is on the first code by default and the light of "-" lights up
6. After selecting the product code ,press knob on the bidet, then press "stop" on the remote control. when long "beep" sound heard, the setting is finished.

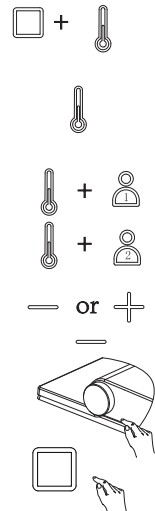

Replacing the batteries

- The remote control requires 2 batteries (type 1.5V LR3/AAA).
- When the user lights flash continuously, please replace the batteries in time.



1. Non-rechargeable batteries are not to be recharged
2. Rechargeable batteries are to be removed from the appliance before being charged
3. Different types of batteries or new and used batteries are not to be mixed
4. Batteries are to be inserted with the correct polarity
5. The exhausted batteries are to be removed from the appliance and safely disposed of
6. If the appliance is to be stored unused for a long period, the batteries should be removed
7. The supply terminals are not to be short-circuited

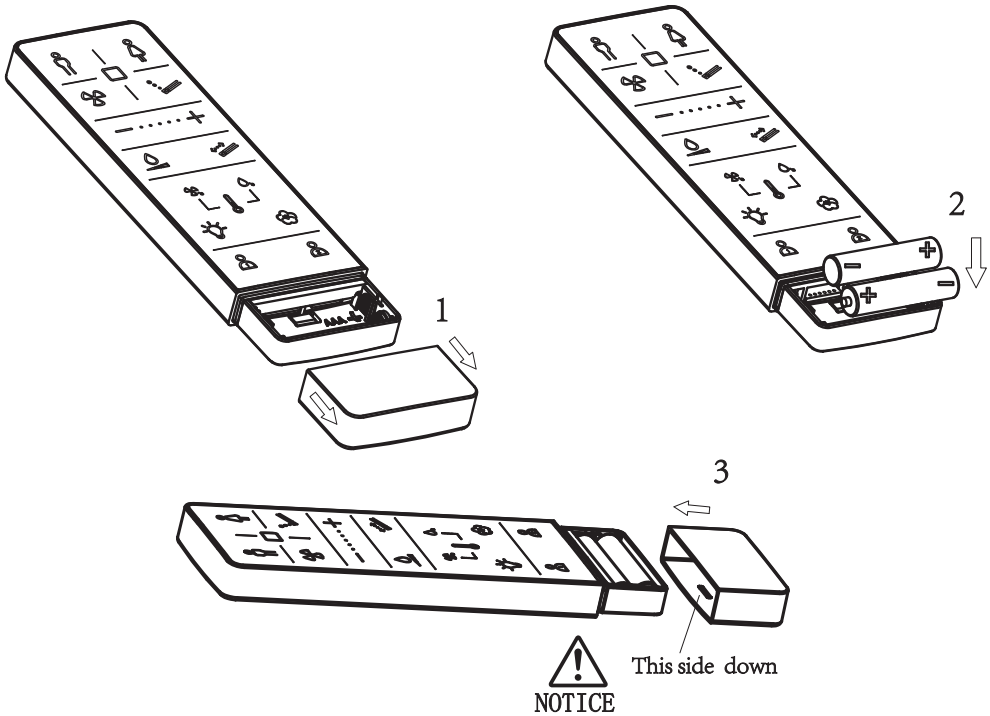

Troubleshooting

Problem	Potential cause	Suggested action
The washing can not work	1. The power supply may not be opened	Please turn on the power
	2. The water supply may not be opened	Please open the inlet water valve, or check if there is a water outage
	3. The filter may be blocked	Please replace a new filter .It has a service life of approx. half a year
	4.Maybe not in the seating state	Please sit on the seat and adjust sitting position
	5.Maybe the cover is closed	Please open the cover and sit on the seat
	6.Maybe it is not used for more than 72 hours	Not used for more than 72 hours ,when the user operates the washing ,it will open the self-cleaning for about 3 minutes. All the buttons are invalid during the self-cleaning and it will return to normal after the self-cleaning
The nozzle goes back suddenly	1.The washing cycle is 3mins. The nozzle will stop spraying after 3mins ,and then go back.	This is normal and please re-press the "wash" button to start washing again
	2.There may be some problems of water supply	Please check if there is a water outage
	3.Maybe the seated sensor detects the user left the seat	Please adjust sitting position
	4.Maybe the cover is closing	Do not put down the cover when it is washing
Low water flow rate	1.The water flow rate may be set at low grades	Please increase the flow rate as per "adjusting water flow rate" of operating instructions
	2.The water supply pressure may be too low	Please check and ensure the water supply pressure is $\geq 0.07\text{Mpa}$
	3.The filter may be blocked	Please replace a new filter .It has a service life of approx. half a year
	4.The nozzle may be blocked	Please replace a new nozzle
Low water temperature	1.The water temperature may be set at low grades	Please set the water temperature at high grade as per "adjusting temperature"of operating instructions
	2.Maybe the temperature of water supply is too low	Please set the water temperature at high grade as per "adjusting temperature"of operating instructions,or decrease the flow rate as per "adjusting water flow rate" of
The nozzle comes out slowly	When start washing function,the nozzle will be self-cleaning before coming out,and this will take some	This is normal
The water flows out but the nozzle do not come out	1.When start washing function,the nozzle will be self-cleaning before coming out .When the washing is over ,also have this feature	This is normal
	2.Maybe it is not used for more than 72 hours	This is normal. Not used for more than 72 hours ,when the user operates the washing ,it will open the self-cleaning for about 3 minutes
The dryer can not work	1. The power supply may not be opened	Please turn on the power
	2.Maybe not in the seating state	Please sit on the seat and adjust sitting position
	3.Maybe the cover is closed	Please open the cover and sit on the seat
	4.Maybe it is not used for more than 72 hours	Not used for more than 72 hours ,when the user operates the washing ,it will open the self-cleaning for about 3 minutes. All the buttons are invalid during the self-cleaning and it will return to normal after the self-cleaning
Low air temperature	1.The air temperature may be set at low grades	Please set the air temperature at high grade as per "adjusting temperature"of operating instructions
	2.The air heater can not work normally	Please contact local distributor
Night light is always off	1.Maybe in the bright environment.	When the night light is set at smart mode,the night light will not work when in the bright environment.
	2.The night light function may be closed.	Please open the night light function and adjust the night light mode as per "Light Setting" of operating instructions
Night light is always on	1.Maybe in the dark environment.	When the night light is set at smart mode,the night light will be always on when in the dark environment
	2.Something may be covered around the knob.	Recover the obstructions around the knob
	3.The night light may be set at always on mode	Please adjust the night light mode as per "Light Setting" of operating instructions
The nozzle goes back automatically when manual cleaning	1.The nozzle goes back after washing 5 minutes.	This is normal
	2.Maybe press the "stop" button	The manual cleaning will be stopped if press the knob or press the "stop" button on the remote control.
	3.Maybe the seated sensor detects that the seat is closing	Please do not put down the seat during the manual cleaning
The remote control is not functioning	1.Maybe there are not batteries in the remote control	Please install the correct batteries in the remote control
	2.Maybe the battery power is too low	When the battery power is too low the LED of grade will flash.Please replace the battery
	3.Maybe the code of the bidet and remote control is not the same	Please set the code of the remote control to the correct one .See "One-On-One Setting"
There are BEEP sounds when the bidet is working	There is a short BEEP when you are sitting down , and a long BEEP when you leave. Also there is a short BEEP when the bidet has received commands.	This is normal. You can turn off the sound. See "Sound Setting"
The bidet can not work normally	Maybe there is something abnormal	Please shut off the power and turn on after one minute. If the bidet still cannot work,please contact local distributor
The light around the knob flash twice with constantly BEEP	The water supply temperature may be too high	Please shut off the power and water supply,stop using the product,and then contact local distributor
The light around the knob keep flashing	There may be something wrong with the product	Please check if the electric power and water supply are normal,cut off the power and restart the product. If the bidet still cannot work,please contact local distributor



NOTICE

Do not dispose of electrical appliances as unsorted municipal waste, use separate collection facilities.

Contact you local government for information regarding the collection systems available. If electrical appliances are disposed of in landfills or dumps, hazardous substances can leak into the groundwater and get into the food chain, damaging your health and well-being. When replacing old appliances with new ones, the retailer is legally obligated to take back your old appliance for disposals at least free of charge.

